



# Speciality Glass Products



28GM JAM JAR

Article Drawing

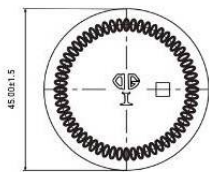
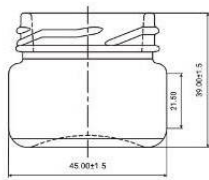

### Technical Specifications

Fill Point-	NIL
Brimfull-	30±2 ml.
Neck Finish-	Lug Finish
Weight-	58±7 gms
Height-	39 mm
Diameter-	45 mm
Bottom-	Knurling On Bearing Surface
Finish Type-	43 mm Lug Cap

200GM TOMATO KETCHUP

Article Drawing

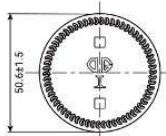
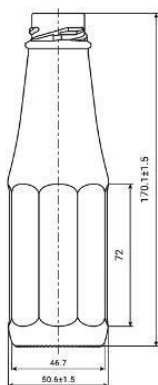

### Technical Specifications

Fill Point-	NIL
Brimfull-	187 ml.
Neck Finish-	Lug Finish
Weight-	160 gms
Height-	170.1 mm
Diameter-	50.6 mm
Bottom-	Crescent Knurling On Bearing Surface
Finish Type-	30 mm Lug Cap

**1 KG TOMATO KETCHUP**

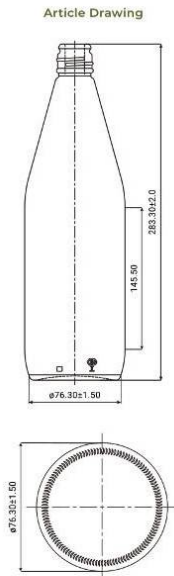

### Technical Specifications

Fill Point-	1 Kg
Brimfull-	920±8 ml.
Neck Finish-	Crown Finish
Weight-	490±20 gms
Height-	283.30 mm
Diameter-	76.30 mm
Bottom-	Crescent Knurling On Bearing Surface
Finish Type-	Crown Beverage

**1 KG TOMATO KETCHUP LUG**

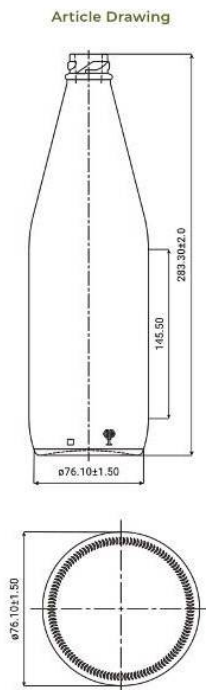

### Technical Specifications

Fill Point-	1 Kg
Brimfull-	920±8 ml.
Neck Finish-	Lug Finish
Weight-	490±20 gms
Height-	283.30 mm
Diameter-	76.10 mm
Bottom-	Crescent Knurling On Bearing Surface
Finish Type-	30 mm Lug Cap

**2 LITRE JAR**

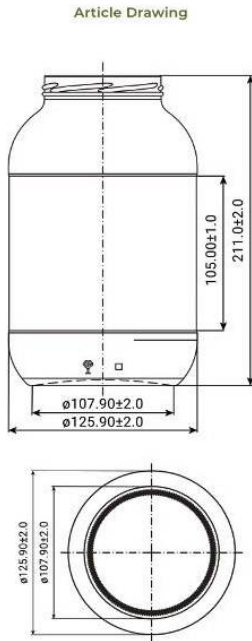

Technical Specifications

Fill Point-	NIL
Brimfull-	2000±15 ml.
Neck Finish-	Lug Finish
Weight-	665±25 gms
Height-	211 mm
Diameter-	108 mm
Bottom-	Crescent Knurling On Bearing Surface
Finish Type-	82 mm Lug Finish With Bead

**50 GM SQUARE COFFEE**

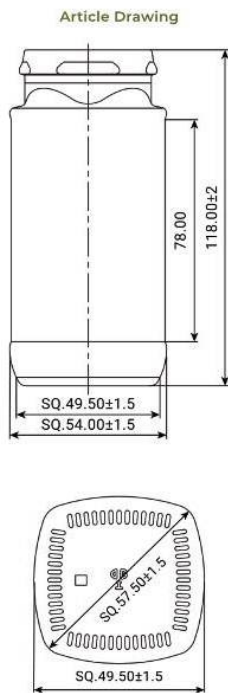

Technical Specifications

Fill Point-	NIL
Brimfull-	205±6 ml.
Neck Finish-	Special Finish
Weight-	175±10 gms
Height-	118 mm
Diameter-	SQ. 49.50 mm
Bottom-	Bar Knurling
Finish Type-	Lug Cap

200GM  
BAMBOO  
BOTTLE

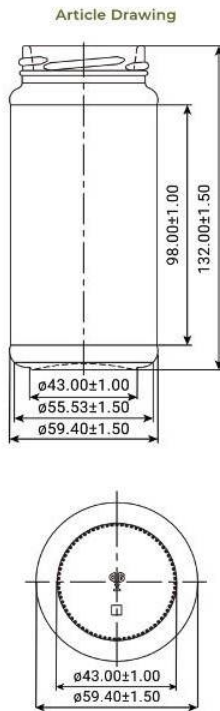

### Technical Specifications

Fill Point-	NIL
Brimfull-	255±6 ml.
Neck Finish-	Lug Finish
Weight-	175±10 gms
Height-	132 mm
Diameter-	43 mm
Bottom-	Dot Knurling On Bearing Surface
Finish Type-	53 mm Lug With Bead

200GM  
JAM  
JAR

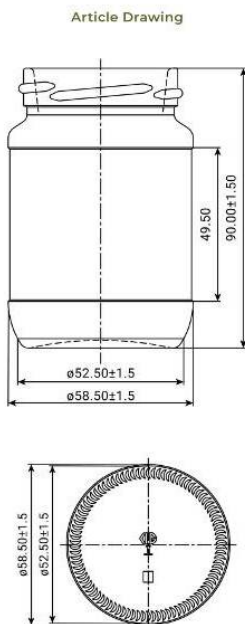

### Technical Specifications

Fill Point-	NIL
Brimfull-	162±5 ml.
Neck Finish-	Lug Finish
Weight-	145±15 gms
Height-	90 mm
Diameter-	52.50 mm
Bottom-	Crescent Knurling On Bearing Surface
Finish Type-	53 mm Lug Cap

2  
0  
0  
G  
M  
M  
I  
L  
M  
A  
G  
H  
E  
E

Article Drawing

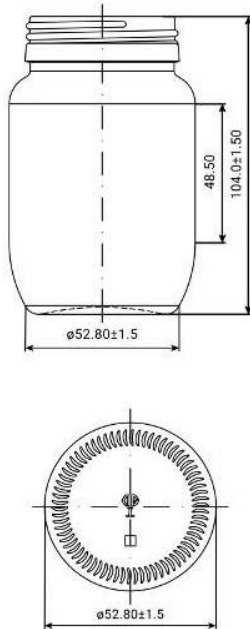

### Technical Specifications

Fill Point-	NIL
Brimfull-	234 $\pm$ 6 ml.
Neck Finish-	ROPP Finish
Weight-	145 $\pm$ 10 gms
Height-	104 mm
Diameter-	52.80 mm
Bottom-	Crescent Knurling On Bearing Surface
Finish Type-	53 mm RO PP STD

2  
0  
0  
G  
M  
N  
U  
R  
R  
I  
S  
H  
O  
L  
D

Article Drawing

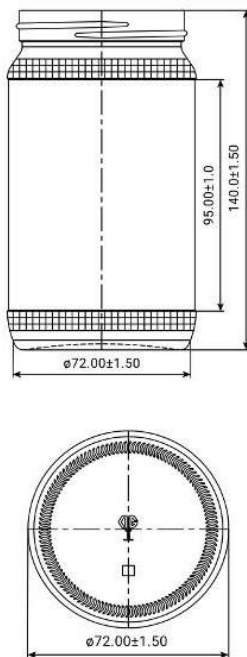

### Technical Specifications

Fill Point-	NIL
Brimfull-	500 $\pm$ 8 ml.
Neck Finish-	Lug Finish
Weight-	270 $\pm$ 15 gms
Height-	140 mm
Diameter-	72 mm
Bottom-	Crescent Knurling On Bearing Surface
Finish Type-	70 mm CF316-B

200GM PICKLE JAR

Article Drawing

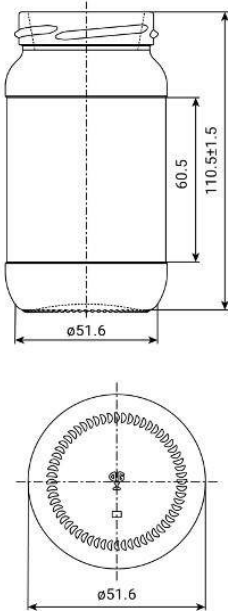

### Technical Specifications

Fill Point-	NIL
Brimfull-	209±5 ml.
Neck Finish-	Lug Finish
Weight-	145±10 gms
Height-	110.5 mm
Diameter-	51.6 mm
Bottom-	Crescent Knurling On Bearing Surface
Finish Type-	53 mm Lug Cap

200ML FLAVOURED MILK BOTTLE

Article Drawing

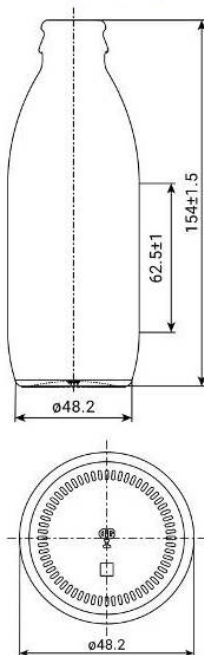

### Technical Specifications

Fill Point-	200
Brimfull-	220±4 ml.
Neck Finish-	Crown Finish
Weight-	150±4.5 gms
Height-	154 mm
Diameter-	48.2 mm
Bottom-	Bar Knurling On Bearing Surface
Finish Type-	655 Crown Cork

250GM SQUARE JAR

Article Drawing

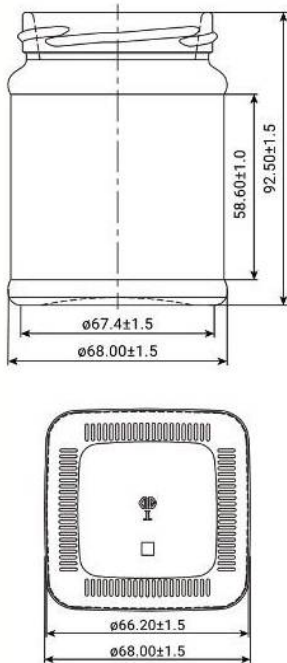

### Technical Specifications

Fill Point-	200
Brimfull-	220±4 ml.
Neck Finish-	CPI Finish
Weight-	120±10 gms
Height-	154±1.5 mm
Diameter-	47 ±1.5 mm
Bottom-	Bar Knurling On Bearing Surface
Finish Type-	CPI 650 CC

200ML FLAVOURED MILK NNB

Article Drawing

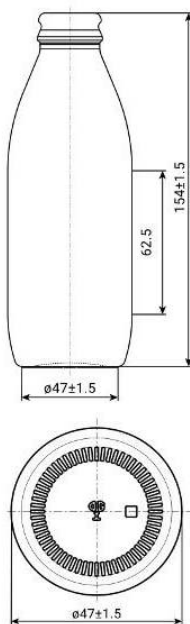

### Technical Specifications

Fill Point-	NIL
Brimfull-	280±6 ml.
Neck Finish-	Lug Finish
Weight-	195±10 gms
Height-	92.50 mm
Diameter-	67.4 m m
Bottom-	Bar Knurling On Bearing Surface
Finish Type-	63 mm Lug Cap



**300GM FUDKOR BOTTLE**

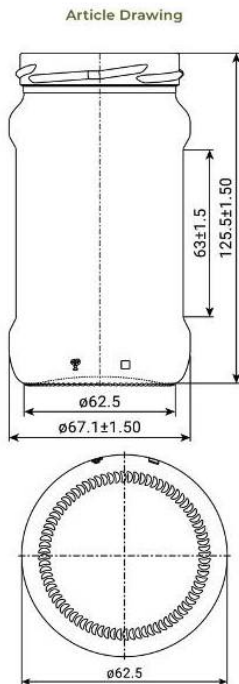

Technical Specifications

Fill Point-	NIL
Brimfull-	300±10 ml.
Neck Finish-	Lug Finish
Weight-	200±15 gms
Height-	125.5±1.5 mm
Diameter-	67.1±1.5 mm
Bottom-	Crescent Knurling On Bearing Surface
Finish Type-	63 mm Lug Cap
Customer-	General Market

**300GM JAI PICKLE JAR**

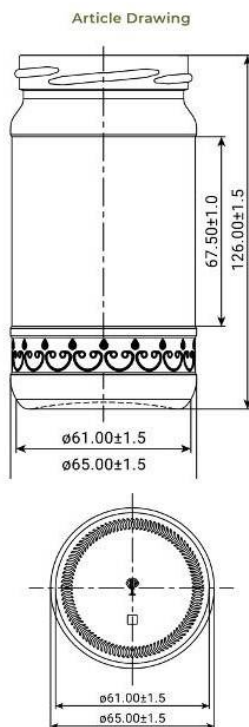

Technical Specifications

Fill Point-	NIL
Brimfull-	308±6 ml.
Neck Finish-	Lug Finish
Weight-	190±12 gms
Height-	126 mm
Diameter-	61 mm
Bottom-	Crescent Knurling On Bearing Surface
Finish Type-	63 mm Lug Cap

**300 ML  
FMS  
MILK  
BOTTLE**

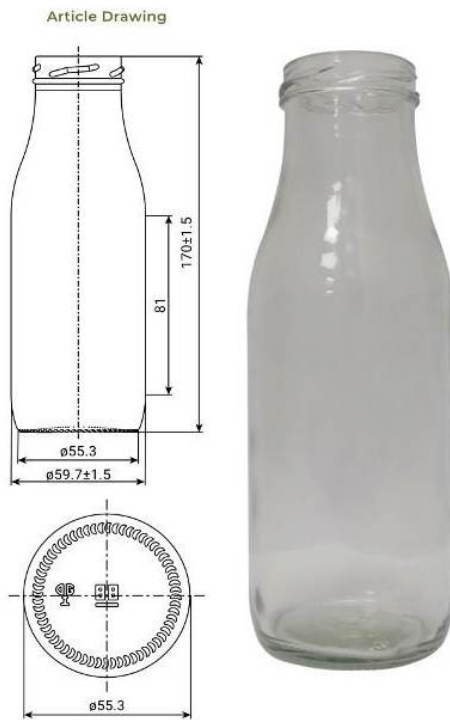

### Technical Specifications

Fill Point-	NIL
Brimfull-	230 ml.
Neck Finish-	Lug Finish
Weight-	175 gms
Height-	96 mm
Diameter-	63 mm
Bottom-	Crescent Knurling On Bearing Surface
Finish Type-	43 mm Lug Cap

**340 GM  
KETCHUP  
BOTTLE**

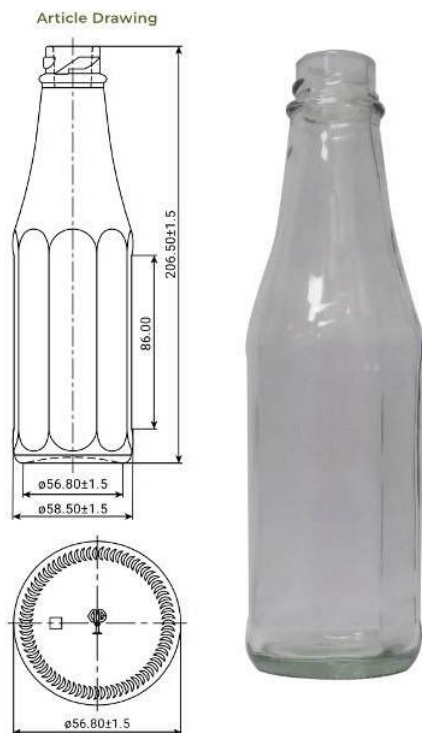

### Technical Specifications

Fill Point-	NIL
Brimfull-	320±6 ml.
Neck Finish-	Lug Finish
Weight-	240±12 gms
Height-	206.50 mm
Diameter-	56.80 mm
Bottom-	Crescent Knurling On Bearing Surface
Finish Type-	30 mm Lug Cap

**370 ML  
FLUTED  
JAR  
ND**

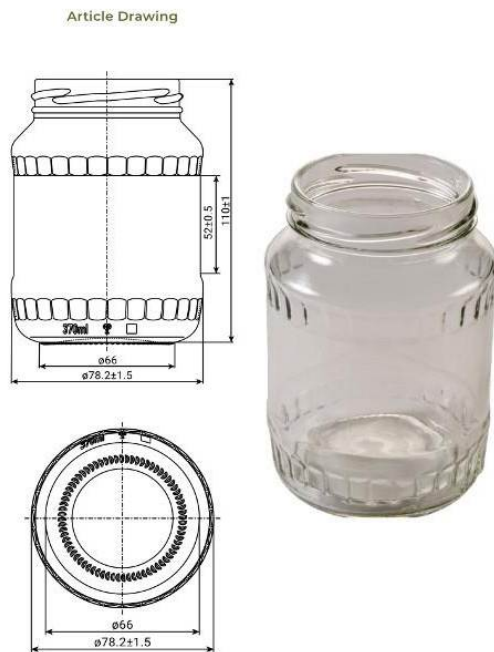

Technical Specifications

Fill Point-	NIL
Brimfull-	370±6 ml.
Neck Finish-	Lug Finish
Weight-	205±10 gms
Height-	110 mm
Diameter-	66 mm
Bottom-	Crescent Knurling On Bearing Surface
Finish Type-	63 Lug Cap With Bead

**370 ML  
JAM  
JAR**



Technical Specifications

Fill Point-	NIL
Brimfull-	370±7 ml.
Neck Finish-	Lug Finish
Weight-	220±12 gms
Height-	85.5 mm
Diameter-	73.5 mm
Bottom-	Crescent Knurling On Bearing Surface
Finish Type-	82 mm Lug Cap With Bead

**3  
7  
0  
M  
L  
  
S  
T  
R  
A  
I  
G  
H  
T  
  
S  
I  
D  
E  
D  
  
J  
A  
R  
  
N  
D**



### Technical Specifications

Fill Point-	NIL
Brimfull-	387±6 ml.
Neck Finish-	Lug Finish
Weight-	180±10 gms
Height-	118 mm
Diameter-	62.4 mm
Bottom-	Crescent Knurling On Bearing Surface
Finish Type-	63 mm Lug Std.

**3  
7  
5  
M  
L  
  
F  
L  
U  
T  
E  
D  
  
J  
A  
R**



### Technical Specifications

Fill Point-	NIL
Brimfull-	398±7 ml.
Neck Finish-	Lug Finish
Weight-	220±15 gms
Height-	127.50 mm
Diameter-	62.4 mm
Bottom-	Crescent Knurling On Bearing Surface
Finish Type-	63 mm Lug Cap

4  
0  
0  
G  
M  
F  
U  
D  
K  
O  
R  
J  
A  
R



### Technical Specifications

Fill Point-	NIL
Brimfull-	380±6 ml.
Neck Finish-	Lug Finish
Weight-	230±15 gms
Height-	130 mm
Diameter-	69.70 mm
Bottom-	Crescent Knurling On Bearing Surface
Finish Type-	63 mm Lug Cap

4  
0  
0  
G  
M  
A  
E  
R  
O  
P  
L  
A  
N  
E  
B  
O  
T  
T  
L  
E



### Technical Specifications

Fill Point-	NIL
Brimfull-	377±7 ml.
Neck Finish-	Lug Finish
Weight-	225±15 gms
Height-	140.9±1.5 mm
Diameter-	68.4±1.5 mm
Bottom-	Crescent Knurling On Bearing Surface
Finish Type-	63 mm Lug STD

400GM STANDARD JAR

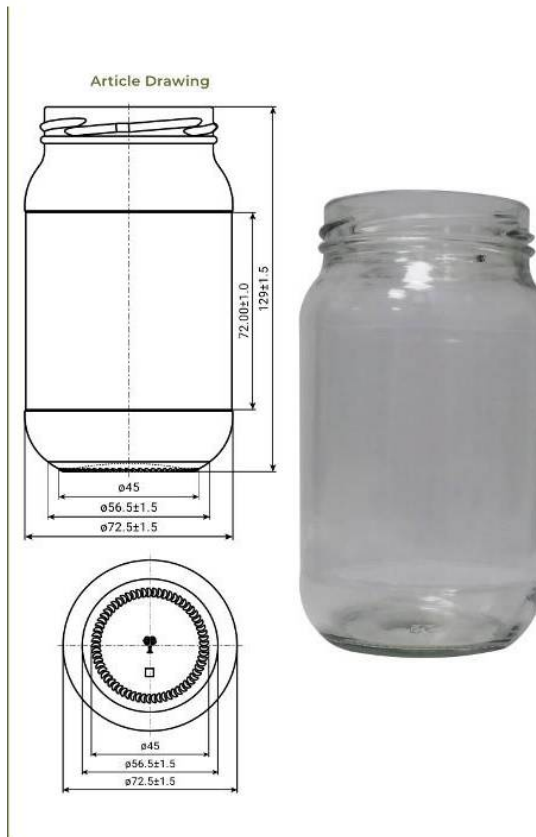

Technical Specifications

Fill Point-	NIL
Brimfull-	400±5 ml.
Neck Finish-	Lug Finish
Weight-	185±15 gms
Height-	129 mm
Diameter-	45 mm
Bottom-	Crescent Knurling On Bearing Surface
Finish Type-	63 mm Lug With Bead

500GM ASHOKA PICKLE BOTTLE



Technical Specifications

Fill Point-	NIL
Brimfull-	470±7 ml.
Neck Finish-	Lug Finish
Weight-	270±20 gms
Height-	145 mm
Diameter-	68.50 mm
Bottom-	Crescent Knurling On Bearing Surface
Finish Type-	63 mm Lug Cap

5  
0  
0  
G  
M  
S  
P  
E  
C  
I  
A  
L  
J  
A  
M  
J  
A  
R

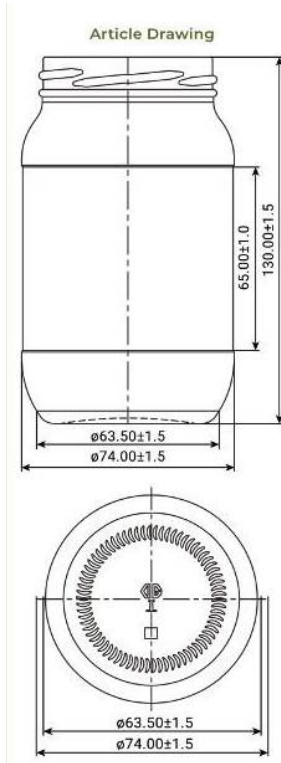

### Technical Specifications

Fill Point-	NIL
Brimfull-	412±5 ml.
Neck Finish-	Lug Finish
Weight-	220±15 gms
Height-	130 mm
Diameter-	63.50 mm
Bottom-	Crescent Knurling On Bearing Surface
Finish Type-	63 mm Lug Cap With Bead

5  
0  
0  
M  
L  
G  
L  
A  
S  
S  
J  
A  
R

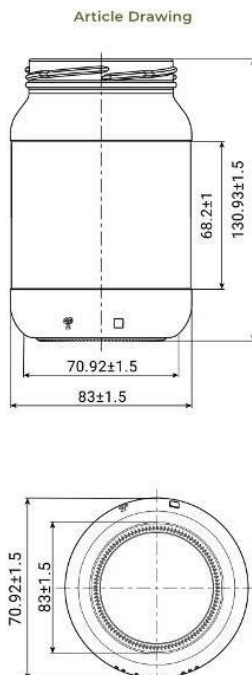

### Technical Specifications

Fill Point-	NIL
Brimfull-	537±7 ml.
Neck Finish-	Lug Finish
Weight-	240±20 gms
Height-	145 mm
Diameter-	68.50 mm
Bottom-	Crescent Knurling On Bearing Surface
Finish Type-	70 mm Lug Cap

5  
2  
5  
M  
L  
G  
L  
O  
B  
A  
L  
J  
A  
R

Article Drawing

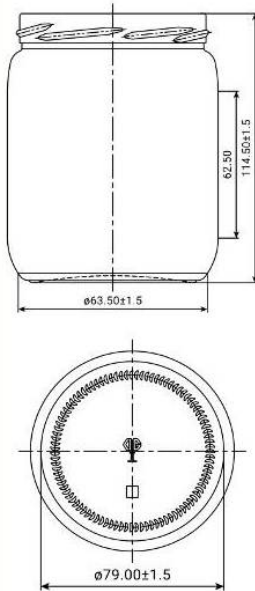

### Technical Specifications

Fill Point-	NIL
Brimfull-	539 $\pm$ 7 ml.
Neck Finish-	Lug Finish
Weight-	270 $\pm$ 12 gms
Height-	114.50 mm
Diameter-	79 mm
Bottom-	Crescent Knurling On Bearing Surface
Finish Type-	82 mm Lug Cap

5  
8  
0  
M  
L  
F  
L  
U  
T  
E  
D  
J  
A  
R

Article Drawing

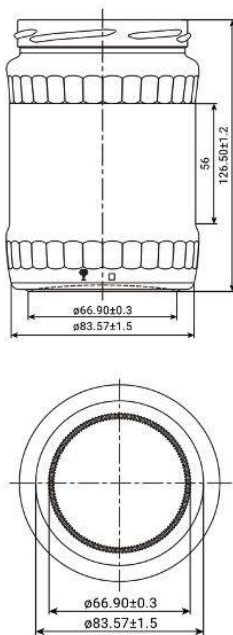

### Technical Specifications

Fill Point-	NIL
Brimfull-	580 $\pm$ 6 ml.
Neck Finish-	Lug Finish
Weight-	290 $\pm$ 25 gms
Height-	126.50 mm
Diameter-	66.90 mm
Bottom-	Crescent Knurling On Bearing Surface
Finish Type-	82 mm Lug Cap



7  
2  
0  
M  
L  
  
F  
L  
U  
T  
E  
D  
  
J  
A  
R

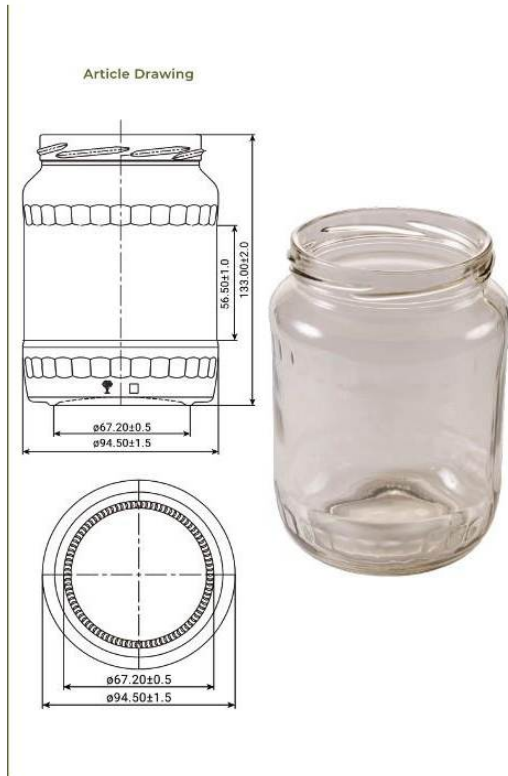

### Technical Specifications

Fill Point-	NIL
Brimfull-	720±8 ml.
Neck Finish-	Lug Finish
Weight-	290±20 gms
Height-	133 mm
Diameter-	67.20 mm
Bottom-	Crescent Knurling On Bearing Surface
Finish Type-	82 mm Lug Cap

7  
2  
0  
M  
L  
  
S  
T  
R  
A  
I  
G  
H  
T  
  
S  
I  
D  
E  
D  
  
J  
A  
R



### Technical Specifications

Fill Point-	NIL
Brimfull-	720±8 ml.
Neck Finish-	Lug Finish
Weight-	310±20 gms
Height-	145.5 mm
Diameter-	80.6 mm
Bottom-	Crescent Knurling On Bearing Surface
Finish Type-	82 mm Lug Cap

7  
5  
0  
M  
L  
P  
L  
A  
I  
N  
B  
O  
T  
T  
L  
E



### Technical Specifications

Fill Point-	NIL
Brimfull-	758±8 ml.
Neck Finish-	Lug Finish
Weight-	350±15 gms
Height-	141.3 mm
Diameter-	67.2 mm
Bottom-	Crescent Knurling On Bearing Surface
Finish Type-	82 mm Lug Finish With Bead

1  
0  
0  
M  
L  
G  
L  
A  
S  
S  
J  
A  
R



### Technical Specifications

Fill Point-	NIL
Brimfull-	1050±14 ml.
Neck Finish-	Lug Finish
Weight-	430±20 gms
Height-	173.60 mm
Diameter-	80.98 mm
Bottom-	Crescent Knurling On Bearing Surface
Finish Type-	82 mm Lug Cap

1000ML MILK BOTTLE

Article Drawing

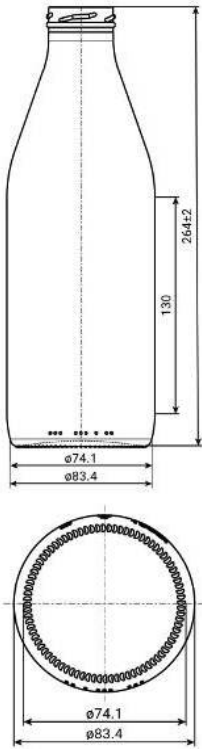

### Technical Specifications

Fill Point-	NIL
Brimfull-	1034±10 ml.
Neck Finish-	Lug Finish
Weight-	440±20 gms
Height-	264 mm
Diameter-	74.1 mm
Bottom-	Crescent Knurling On Bearing Surface
Finish Type-	43 mm Lug CME 20-03

1700ML GLASS JAR

Article Drawing

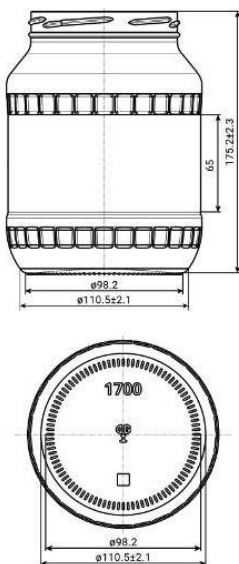

### Technical Specifications

Fill Point-	NIL
Brimfull-	1415±15 ml.
Neck Finish-	Lug Finish
Weight-	550±20 gms
Height-	158.75 mm
Diameter-	99.21 mm
Bottom-	Dot Knurling On Bearing Surface
Finish Type-	82 mm Lug Cap



## Technical Specifications

Fill Point-	NIL
Brimfull-	1700±25 ml.
Neck Finish-	Lug Finish
Weight-	685±25 gms
Height-	175.2 mm
Diameter-	65 mm
Bottom-	Knurling On Bearing Surface
Finish Type-	100 mm Lug Cap



5 ml



11 ml



5 ml, 12 ml



15 ml



7 ml



5 ml



100 ml



100 ml



100 ml



6 ml, 8 ml



30 ml, 60 ml, 70ml



100 ml



100 ml



100 ml



30 ml, 60 ml, 70ml



3 ml, 6 ml



12 ml



10 ml



60 ml



10 g, 30 g, 50 g, 100 g



30 ml



100 g



50 g



30 g



10 g



30 ml



10 z and 1.50 z



10 ml, 30 ml





## AL ASHWIN

---

### INDIA SOURCING LIMITED



No.3, Balaji Street, M.G.M. Nagar, Avaniyapuram, Bye Pass Road,  
Madurai - 625 012, TamilNadu , INDIA.



+ 91 74180 53336 , +91 78450 63338



+91 74022 02341



[trade@alashwin.in](mailto:trade@alashwin.in)  
[sales.alashwin@gmail.com](mailto:sales.alashwin@gmail.com)



[www.suryahomeware.com](http://www.suryahomeware.com)